

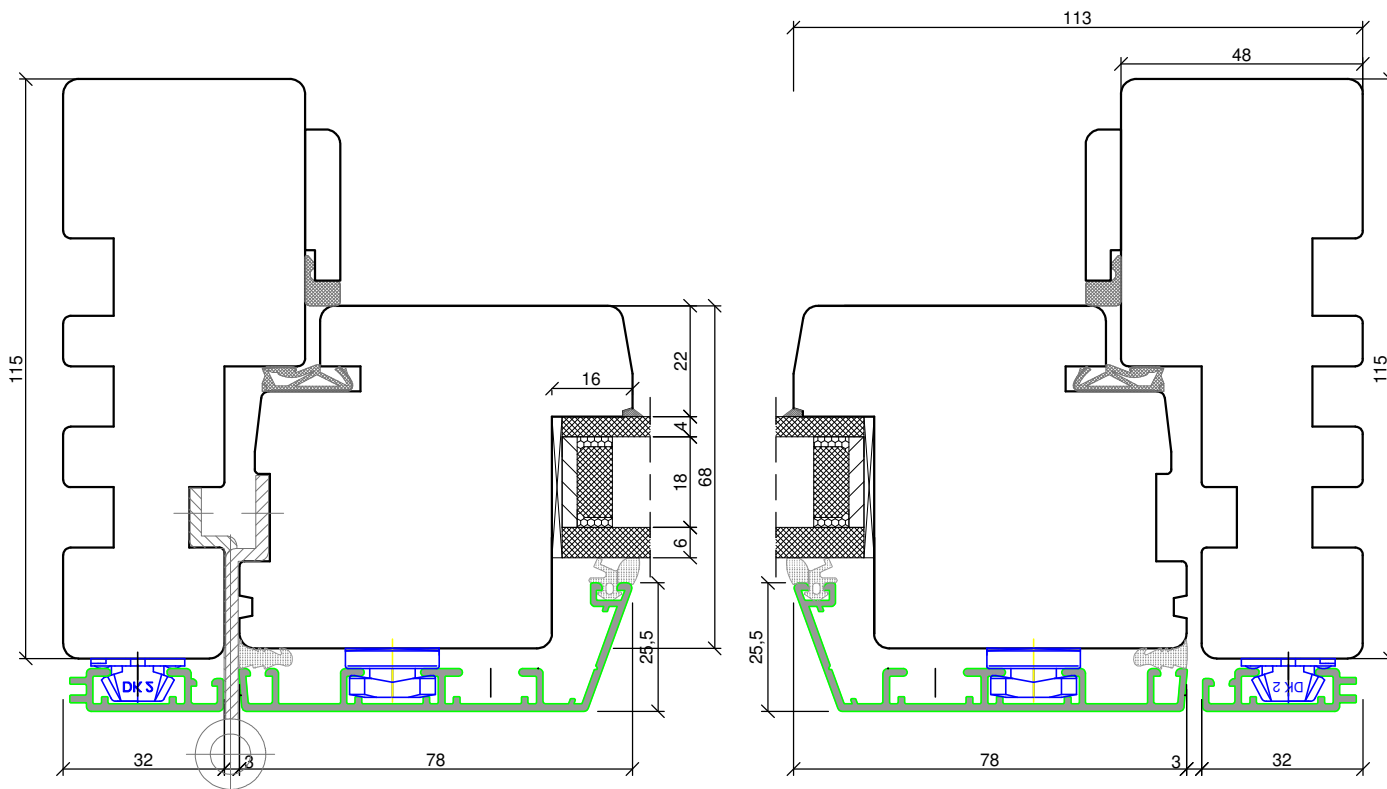

**PPUH DARIUSZ MALEC**  
78-200 Białogard, ul. Królowej Jadwigi 13E  
tel. 94 312 24 77 NIP: 669-000-73-06

[www.malecokna.pl](http://www.malecokna.pl)  
[malec@partner.net.pl](mailto:malec@partner.net.pl) [malec.biuro@o2.pl](mailto:malec.biuro@o2.pl)

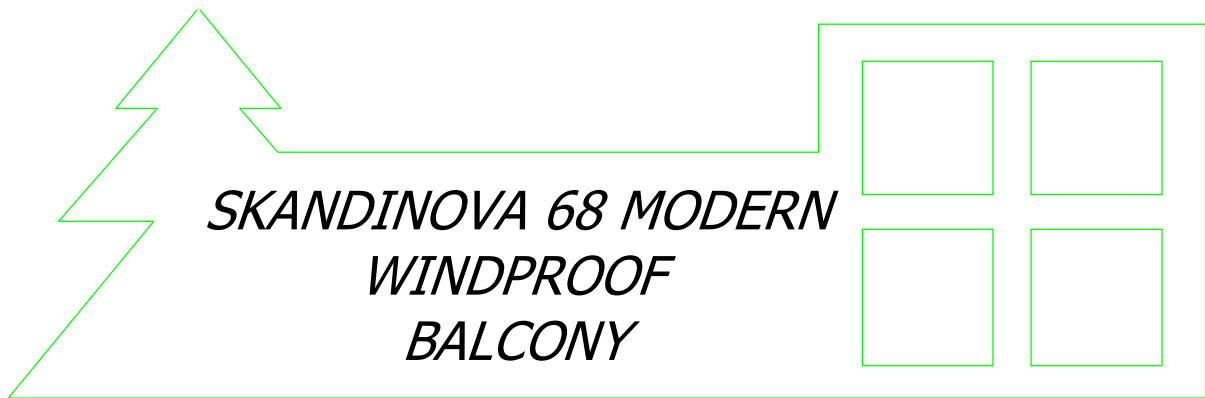

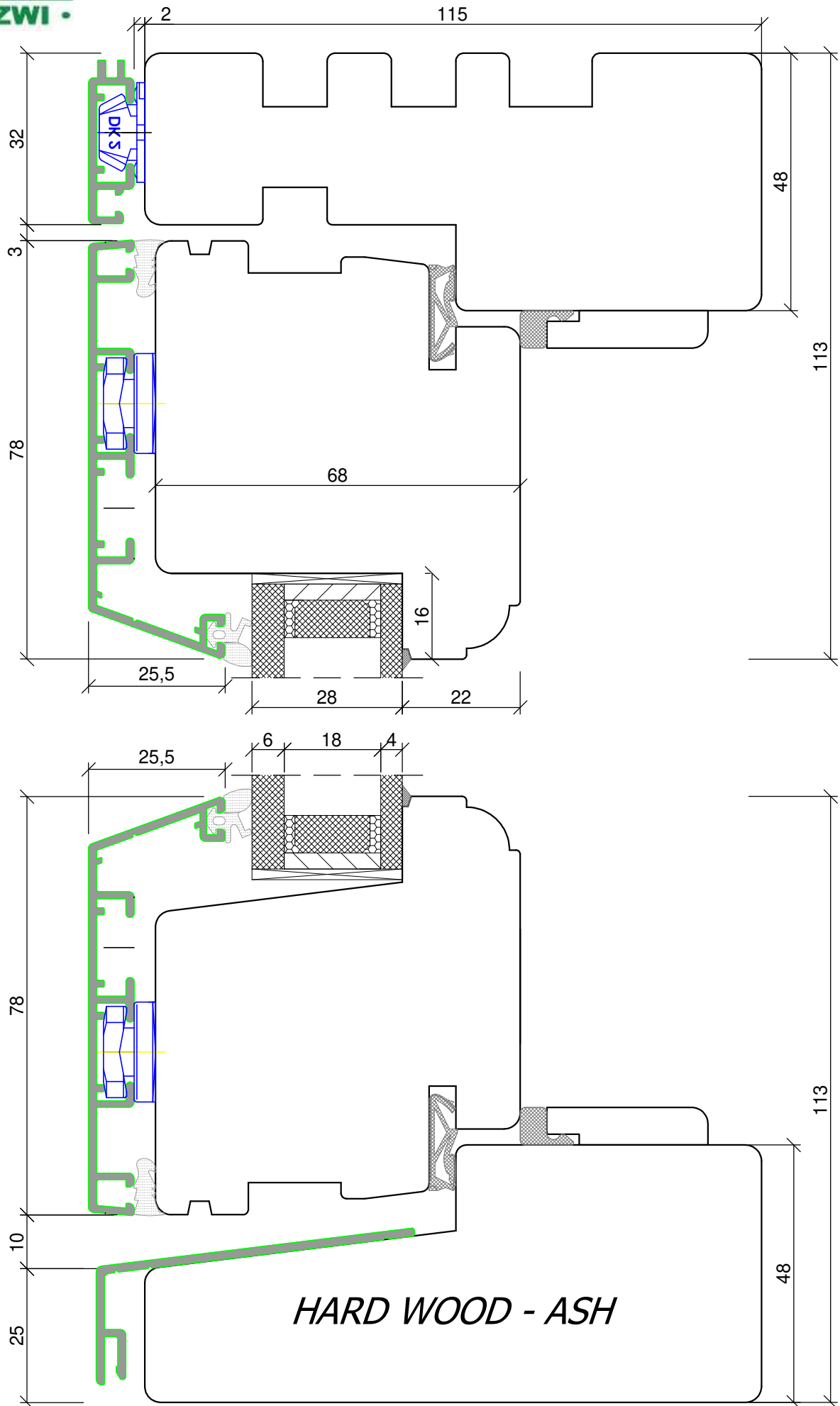



**PPUH DARIUSZ MALEC**  
78-200 Białogard, ul. Królowej Jadwigi 13E  
tel. 94 312 24 77 NIP: 669-000-73-06

[www.malecokna.pl](http://www.malecokna.pl)  
[malec@partner.net.pl](mailto:malec@partner.net.pl) [malec.biuro@o2.pl](mailto:malec.biuro@o2.pl)

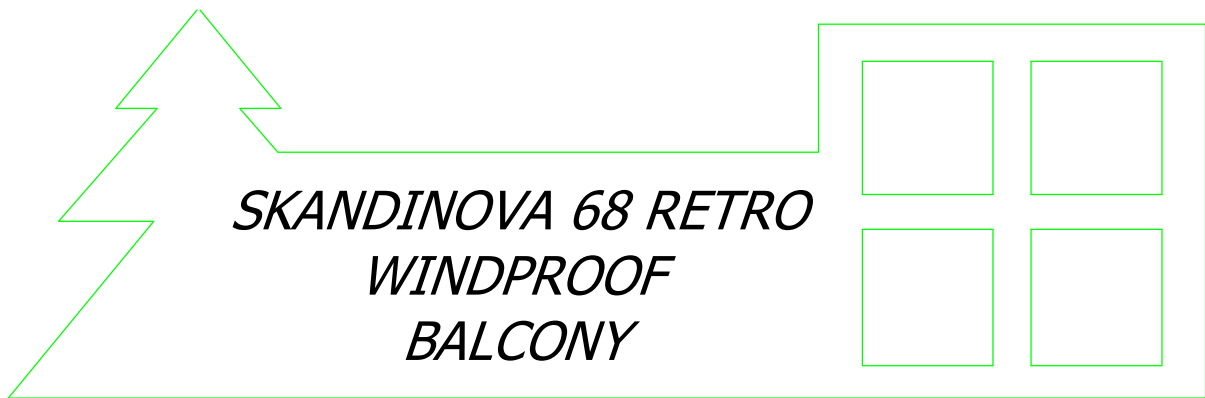

*SKANDINOVA 68 RETRO  
WINDPROOF  
BALCONY*

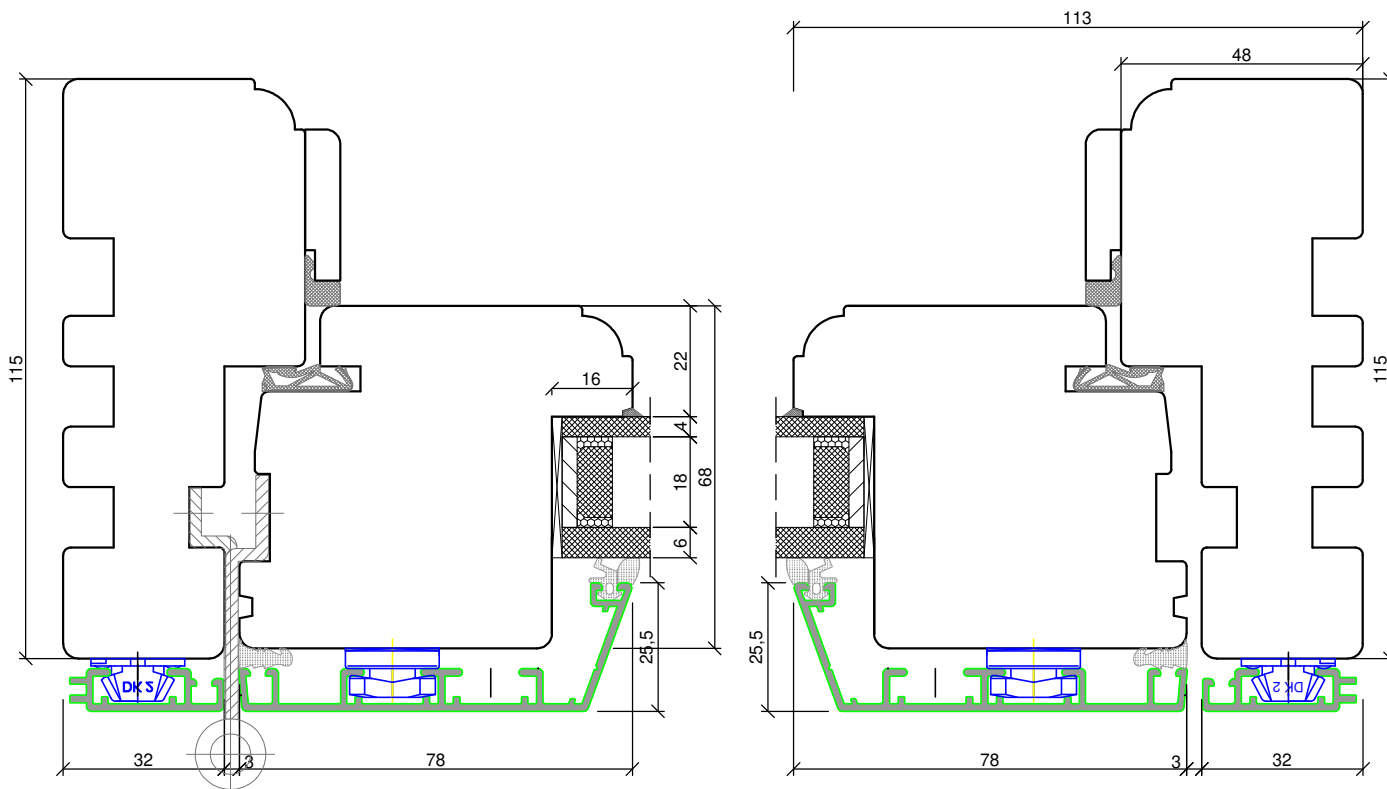



*SKANDINOVA 68 MODERN  
WINDPROOF  
FEST/FIX*

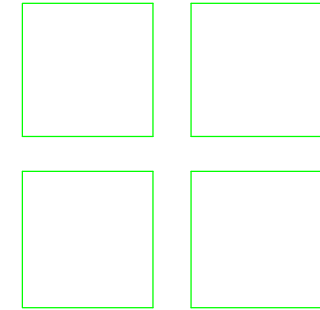

**PPUH DARIUSZ MALEC**  
78-200 Białogard, ul. Królowej Jadwigi 13E  
tel. 94 312 24 77 NIP: 669-000-73-06  
[www.malecokna.pl](http://www.malecokna.pl)  
[malec@partner.net.pl](mailto:malec@partner.net.pl) [malec.biuro@o2.pl](mailto:malec.biuro@o2.pl)

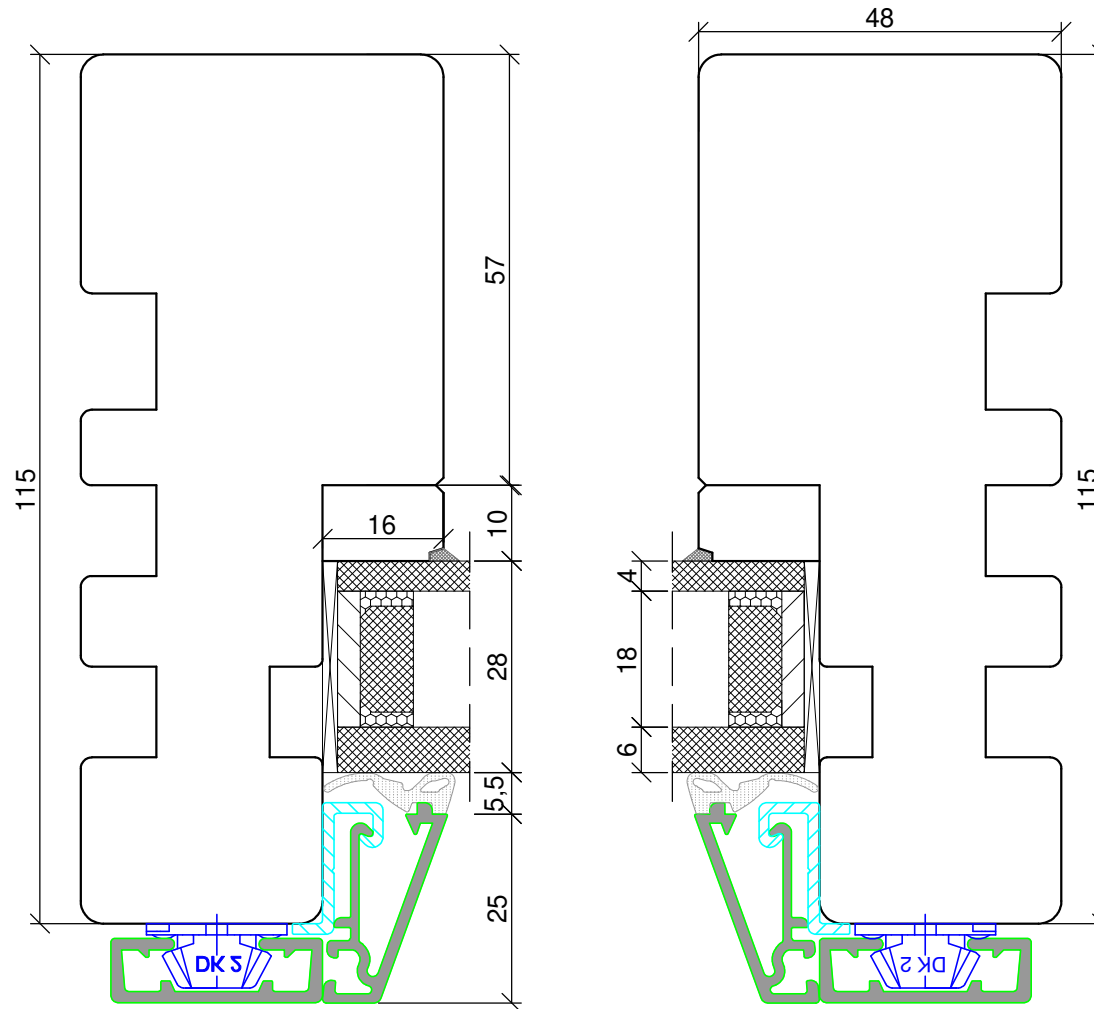

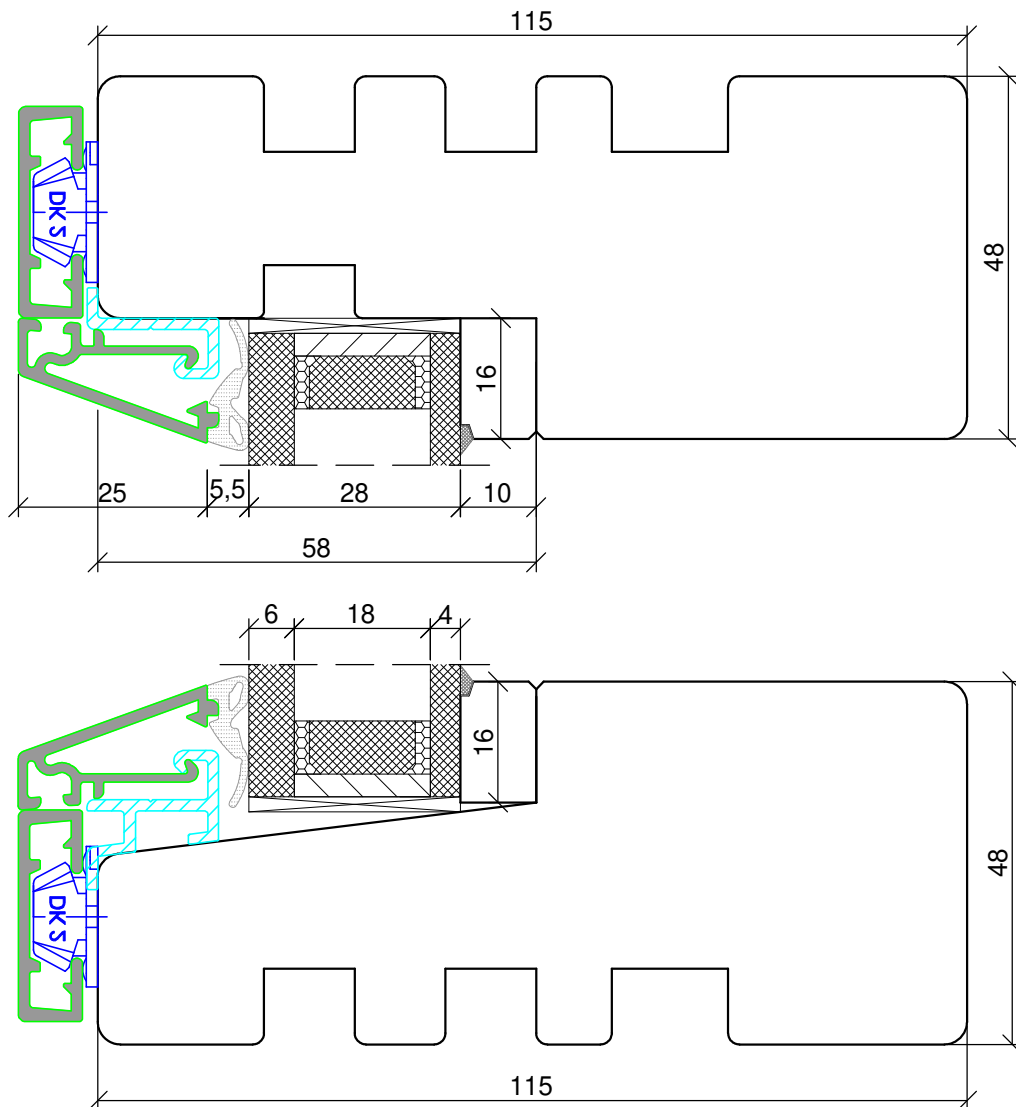



**PPUH DARIUSZ MALEC**  
78-200 Białogard, ul. Królowej Jadwigi 13E  
tel. 94 312 24 77 NIP: 669-000-73-06

[www.malecokna.pl](http://www.malecokna.pl)  
[malec@partner.net.pl](mailto:malec@partner.net.pl) [malec.biuro@o2.pl](mailto:malec.biuro@o2.pl)

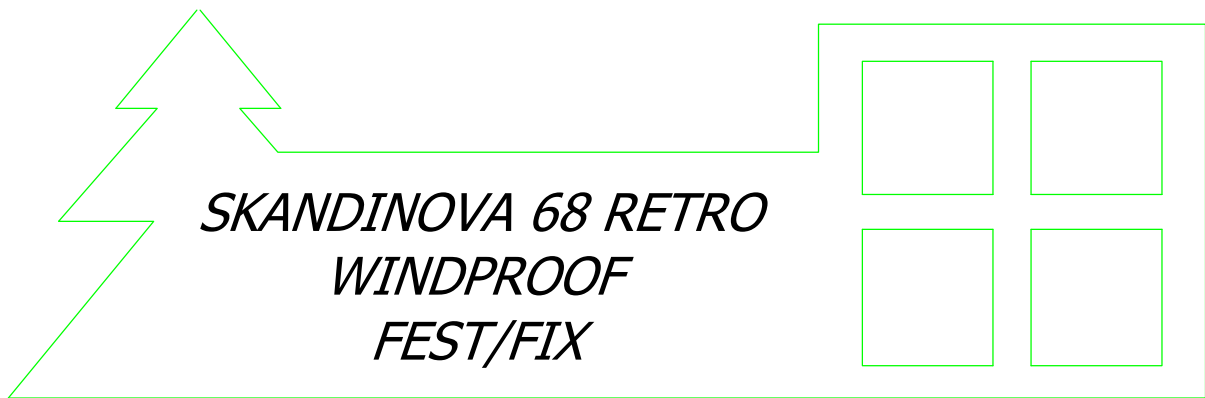

*SKANDINOVA 68 RETRO  
WINDPROOF  
FEST/FIX*

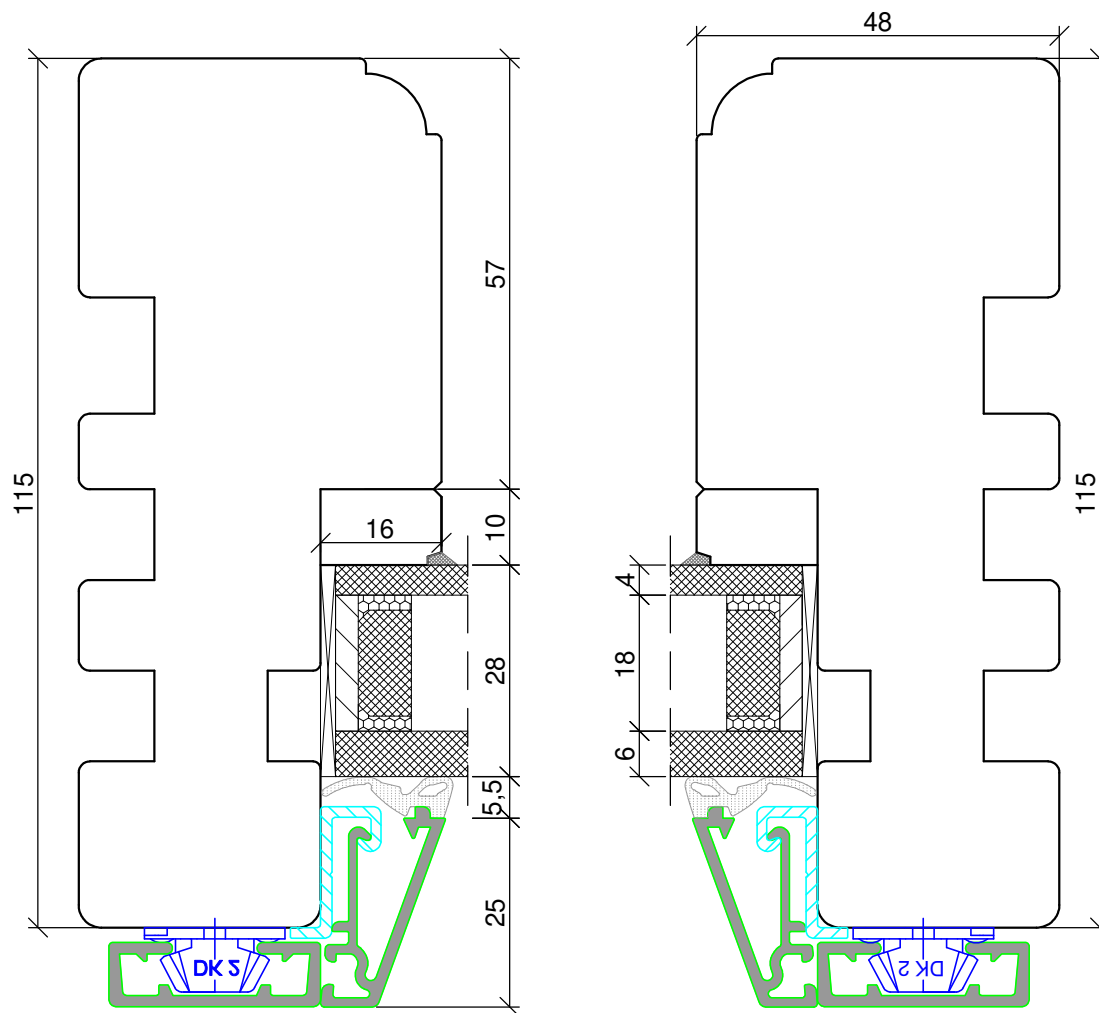

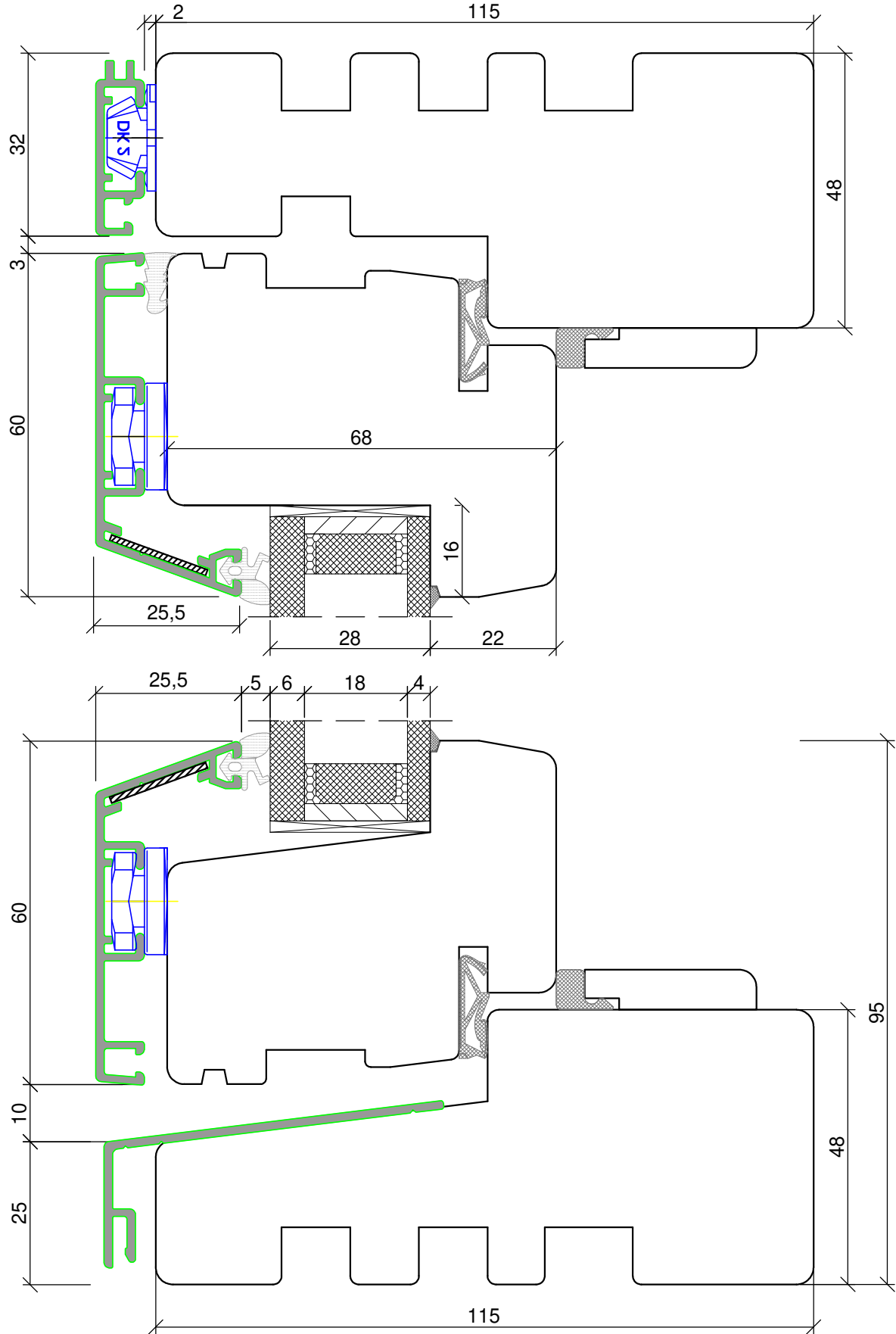
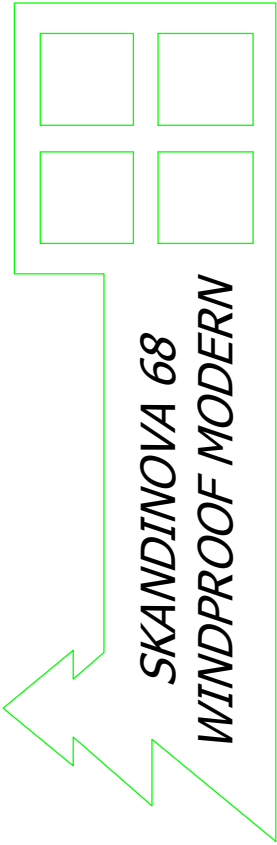





**PPUH DARIUSZ MALEC**  
78-200 Białogard, ul. Królowej Jadwigi 13E  
tel. 94 312 24 77 NIP: 669-000-73-06

[www.malecokna.pl](http://www.malecokna.pl)

[malec@partner.net.pl](mailto:malec@partner.net.pl) [malec.biuro@o2.pl](mailto:malec.biuro@o2.pl)



**SKANDINOVA 68**  
**WINDPROOF MODERN**

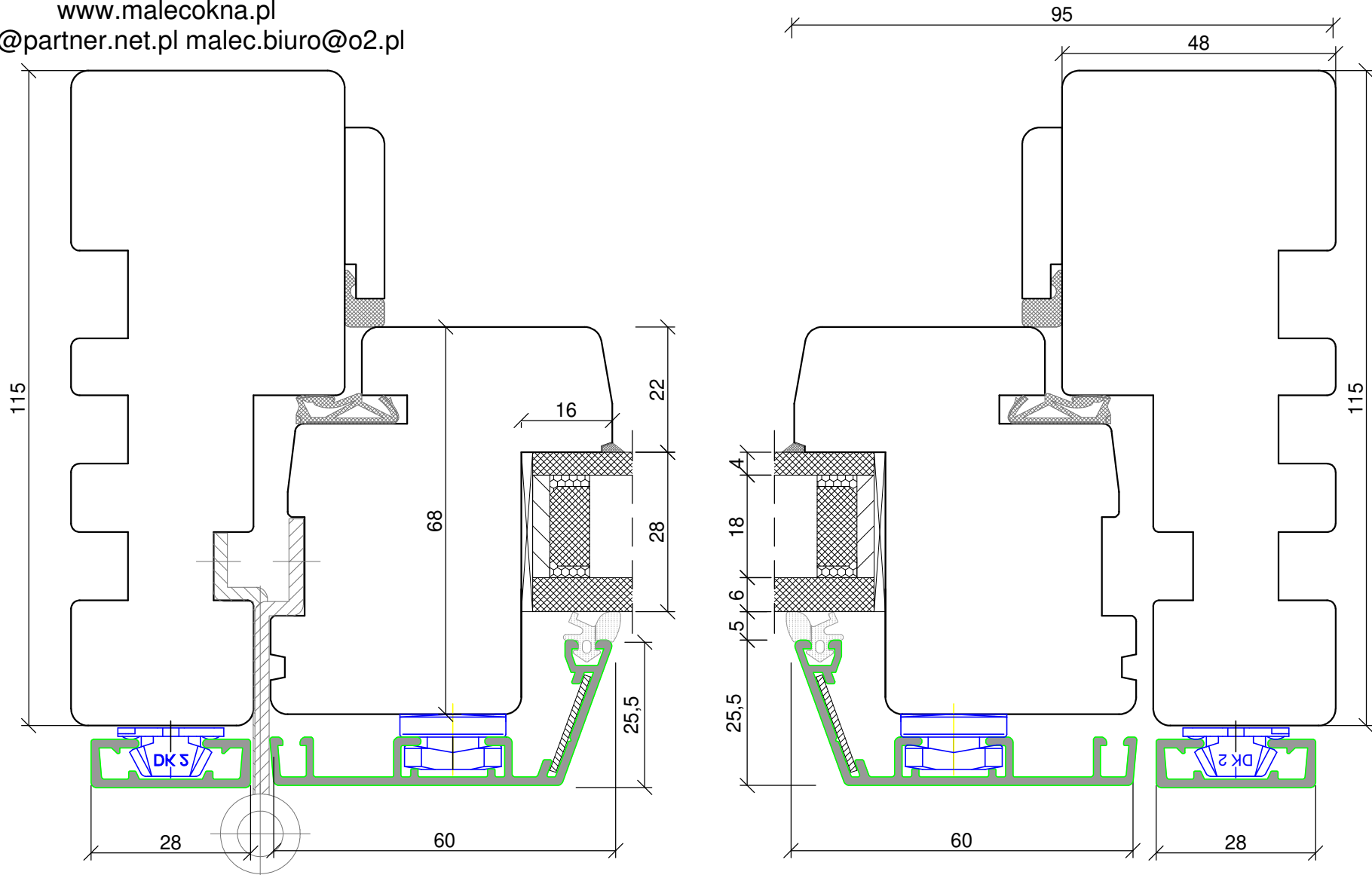

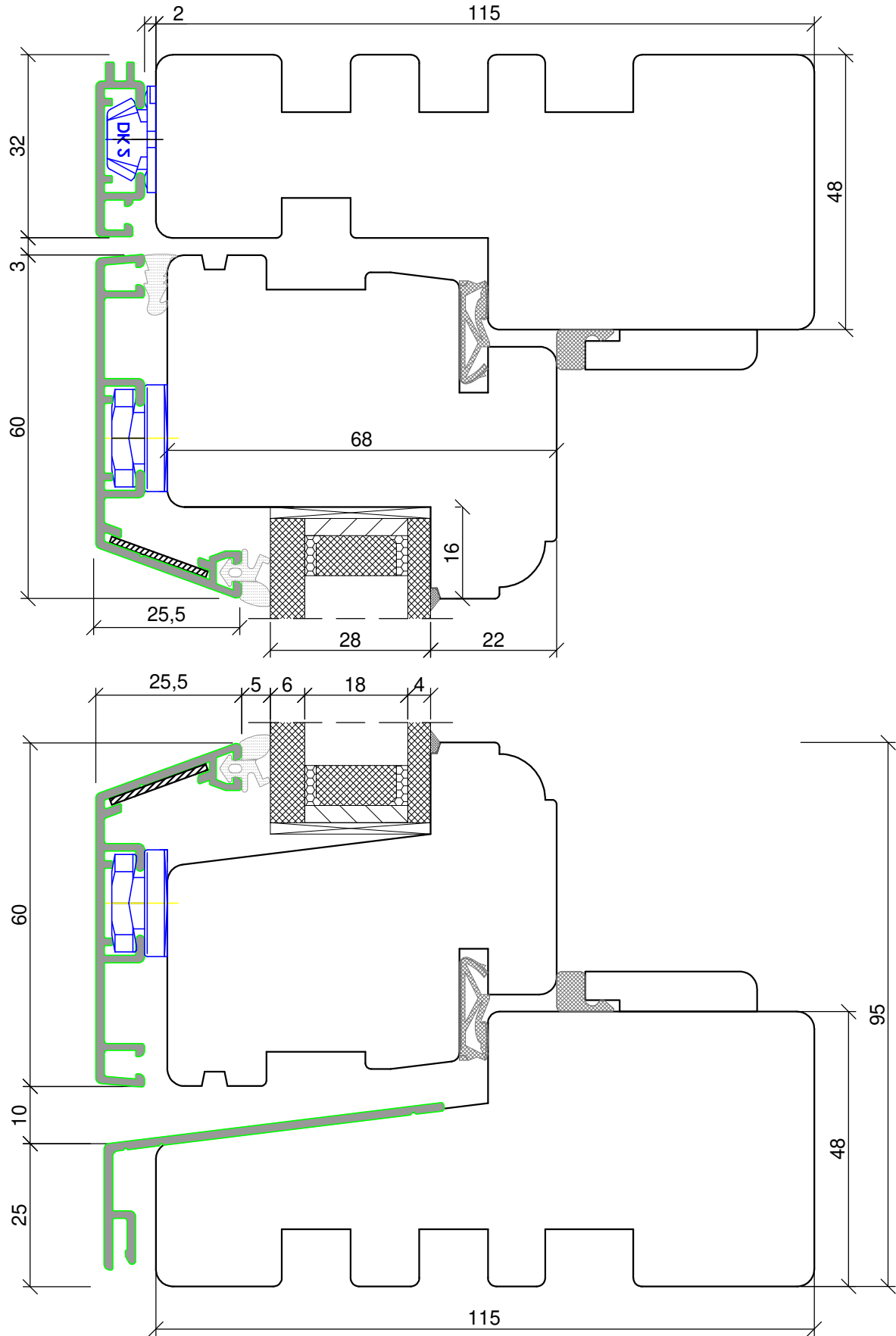



**PPUH DARIUSZ MALEC**

78-200 Białogard, ul. Królowej Jadwigi 13E

tel. 94 312 24 77 NIP: 669-000-73-06

[www.malecokna.pl](http://www.malecokna.pl)

[malec@partner.net.pl](mailto:malec@partner.net.pl) [malec.biuro@o2.pl](mailto:malec.biuro@o2.pl)

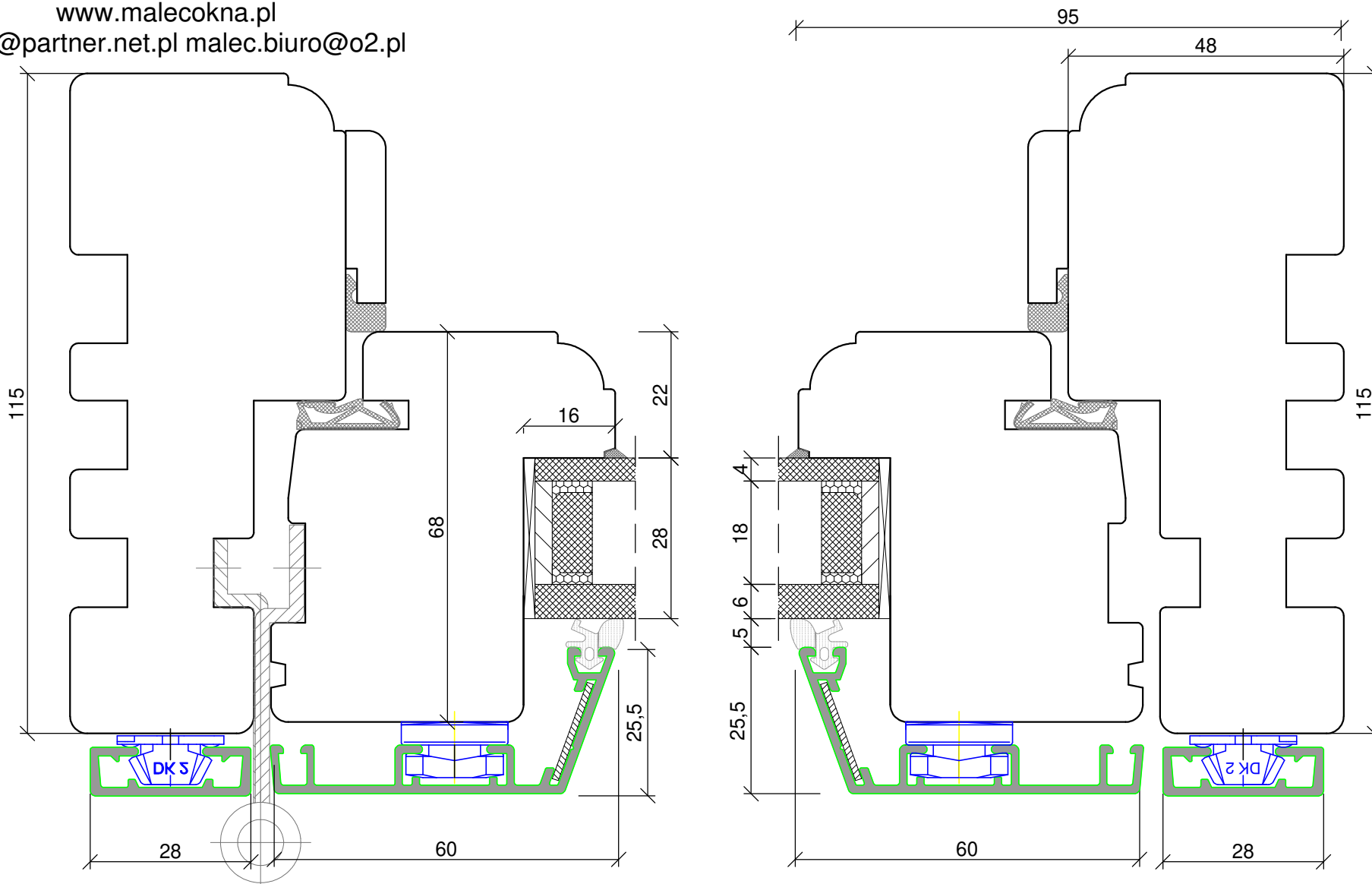
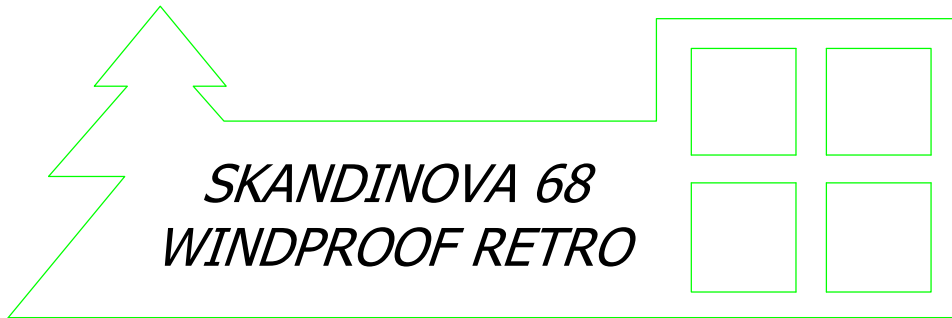



*SKANDINOVA 68 MODERN  
WINDPROFF DOUBLE  
WING*

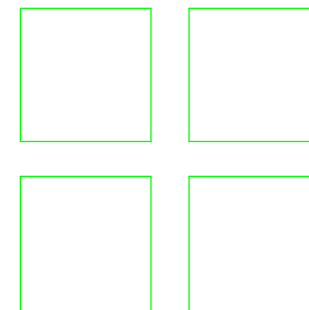

**PPUH DARIUSZ MALEC**  
78-200 Białogard, ul. Królowej Jadwigi 13E  
tel. 94 312 24 77 NIP: 669-000-73-06  
[www.malecokna.pl](http://www.malecokna.pl)  
[malec@partner.net.pl](mailto:malec@partner.net.pl) [malec.biuro@o2.pl](mailto:malec.biuro@o2.pl)

